

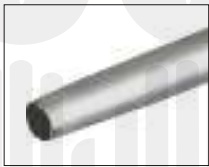

HEBU **NEUROLINE**

Saugrohre für die Neurochirurgie
Suction Tubes for the neurosurgery
Tubes d'aspiration pour la neurochirurgie
Tubos de aspiración para la neurocirugía



- Tränenförmige Sogsteuerung an Fingerplatte für eine sehr präzise Saugregulation
- Biegbares Material zum individuellen Formen des Saugrohres
- Konisches Design des Saugrohres verhindert verstopfen
- Umfangreiches Produktprogramm: 4 Längen und 7 Durchmesser von 4-12. Charr.
- Lieferung mit Reinigungsdraht

- Tear drop shaped thumb control for a very precise suction regulation
- Malleable material for individual forming of the suction hose
- Conical design of the tube prevents plugging
- Comprehensive product program: 4 length and 7 diameters from 4 to 12 Charr.
- Delivered with stylet

- Commande de succion en forme de larme sur contreplaque pour une régulation de l'aspiration de grande précision
- Matière souple permettant l'adaptation individuelle du tube d'aspiration
- Design conique du tube d'aspiration s'opposant à l'engorgement
- Large gamme de produits: 4 longueurs et 7 diamètres de 4 à 12 Charr.
- Livraison avec fil de nettoyage

- Mando succionador en forma de lágrima en la contraplaca para conseguir una regulación de la aspiración muy precisa
- Material flexible para modelar individualmente el tubo de aspiración
- El diseño cónico del tubo de aspiración impide la obstrucción
- Amplio programa de productos: 4 longitudes y 7 diámetros de 4-12 charr.
- Suministro con alambre de limpieza

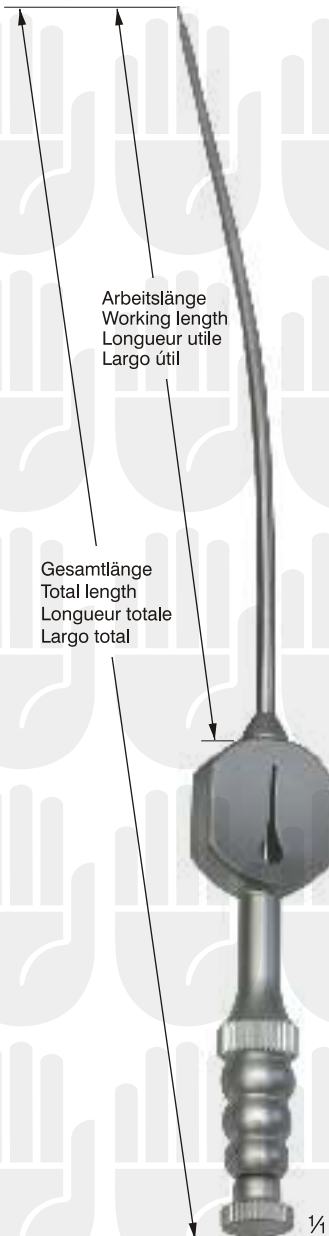

Saugrohr, konisch, biegsam, tränenförmige Sogsteuerung an Fingerplatte
 Suction tube, tapered, malleable, teardrop suction control on fingerplate
 Tube d'aspiration, conique, malléable, commande de succion en forme de larme sur contreplaque
 Tubo de aspiración, cónica, maleable, mando succionador en forma de lágrima en la contraplaca

Charr.	Ø mm	100 mm	115 mm	140 mm	165 mm	Arbeitslänge Working length Longueur utile Largo útil
		165 mm	180 mm	205 mm	230 mm	Gesamtlänge Total length Longueur totale Largo total
4	1,3 mm	HB 2665-04	HB 2665-14	HB 2665-24	HB 2665-34	
5	1,6 mm	HB 2665-05	HB 2665-15	HB 2665-25	HB 2665-35	
6	2,0 mm	HB 2665-06	HB 2665-16	HB 2665-26	HB 2665-36	
7	2,3 mm	HB 2665-07	HB 2665-17	HB 2665-27	HB 2665-37	
8	2,6 mm	HB 2665-08	HB 2665-18	HB 2665-28	HB 2665-38	
9	3,0 mm	HB 2665-09	HB 2665-19	HB 2665-29	HB 2665-39	
12	4,0 mm	HB 2665-12	HB 2665-22	HB 2665-32	HB 2665-42	

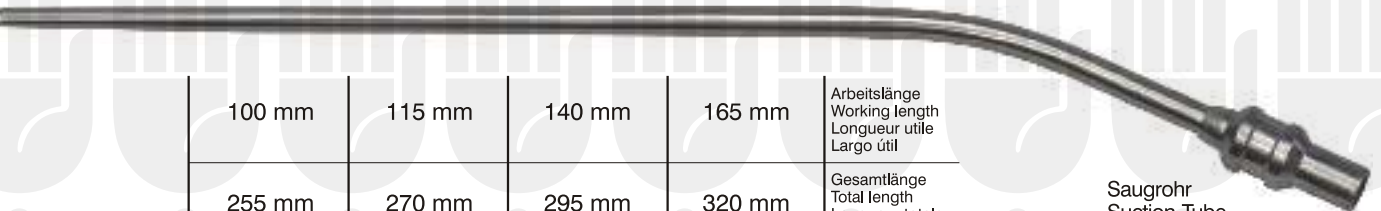
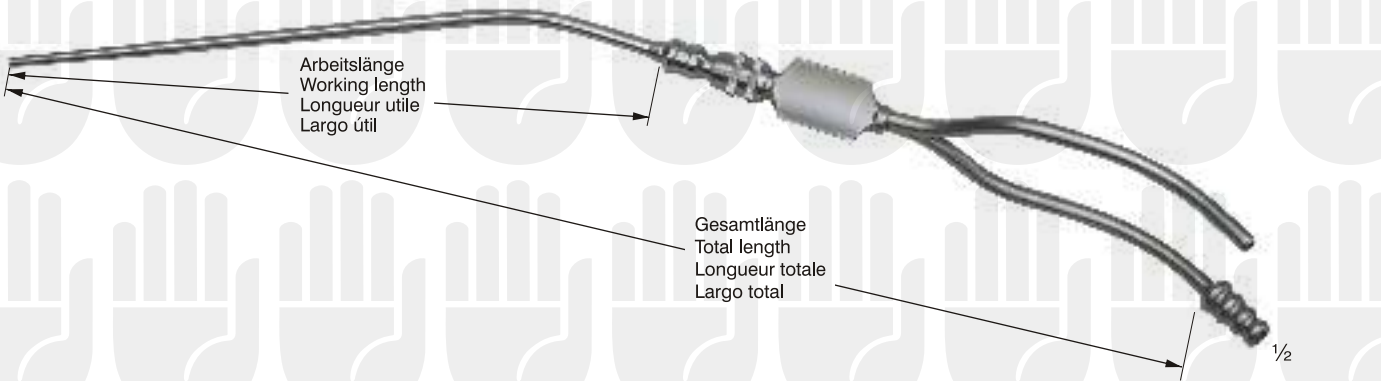

Charr. Ø mm	100 mm		115 mm		140 mm		165 mm		Arbeitslänge Working length Longueur utile Largo útil
	255 mm		270 mm		295 mm		320 mm		Gesamtlänge Total length Longueur totale Largo total
4	1,3 mm	HB 2666-04	HB 2666-14	HB 2666-24	HB 2666-34				
5	1,6 mm	HB 2666-05	HB 2666-15	HB 2666-25	HB 2666-35				
6	2,0 mm	HB 2666-06	HB 2666-16	HB 2666-26	HB 2666-36				
7	2,3 mm	HB 2666-07	HB 2666-17	HB 2666-27	HB 2666-37				
8	2,6 mm	HB 2666-08	HB 2666-18	HB 2666-28	HB 2666-38				
9	3,0 mm	HB 2666-09	HB 2666-19	HB 2666-29	HB 2666-39				
12	4,0 mm	HB 2666-12	HB 2666-22	HB 2666-32	HB 2666-42				

Saugrohr
Suction Tube
Tube d'aspiration
Tubo de aspiración

1/4



HB 2666-00
Griffstück
Handle
Poignée
Empuñadura

1/4

gerade / straight / droits / rectas



Charr. Ø mm		85 mm	100 mm	Arbeitslänge Working length Longueur utile Largo útil
		135 mm	140 mm	Gesamtlänge Total length Longueur totale Largo total
5	1,6 mm	HB 2667-05	HB 2667-15	
7	2,3 mm	HB 2667-07	HB 2667-17	
10	3,3 mm	HB 2667-00	HB 2667-10	

Atraumatische Saugrohrspitze
 Atraumatic Tip Suction Tubes
 Pointe de tube d'aspiration atraumatique
 Punta del tubo de aspiración atraumática



abgewinkelt / angled / coudées / acodadas

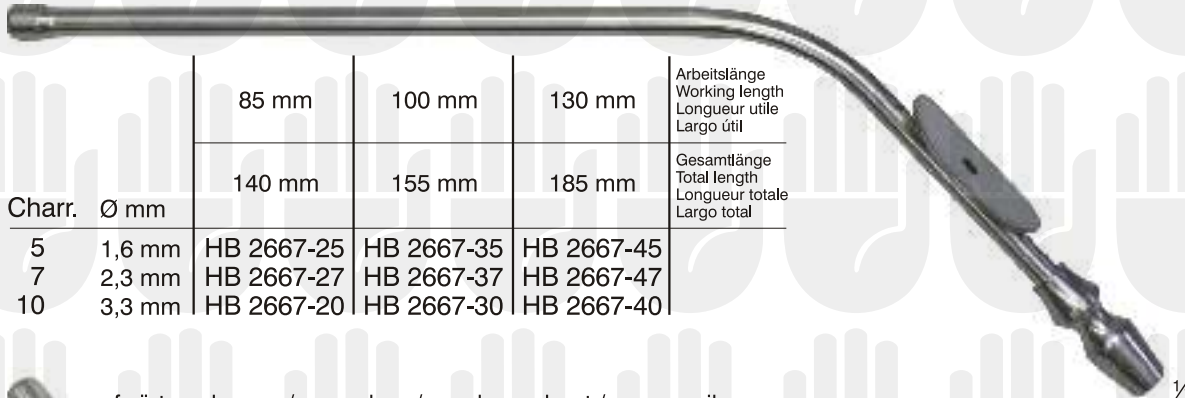

Charr. Ø mm		85 mm	100 mm	130 mm	Arbeitslänge Working length Longueur utile Largo útil
		140 mm	155 mm	185 mm	Gesamtlänge Total length Longueur totale Largo total
5	1,6 mm	HB 2667-25	HB 2667-35	HB 2667-45	
7	2,3 mm	HB 2667-27	HB 2667-37	HB 2667-47	
10	3,3 mm	HB 2667-20	HB 2667-30	HB 2667-40	

aufwärts gebogen / curved up / courbe en haut / curva arriba

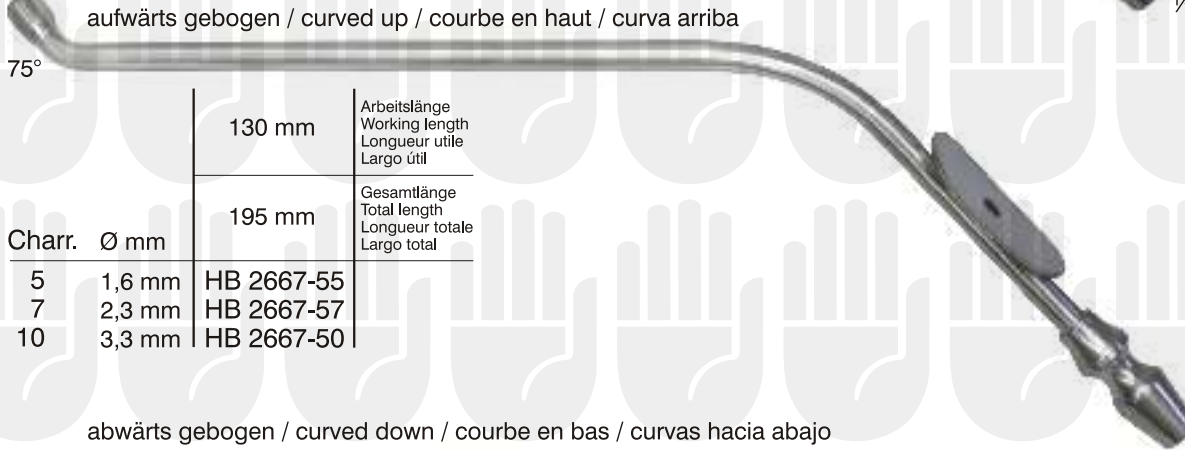

Charr. Ø mm		130 mm	Arbeitslänge Working length Longueur utile Largo útil
		195 mm	Gesamtlänge Total length Longueur totale Largo total
5	1,6 mm	HB 2667-55	
7	2,3 mm	HB 2667-57	
10	3,3 mm	HB 2667-50	

abwärts gebogen / curved down / courbe en bas / curvas hacia abajo

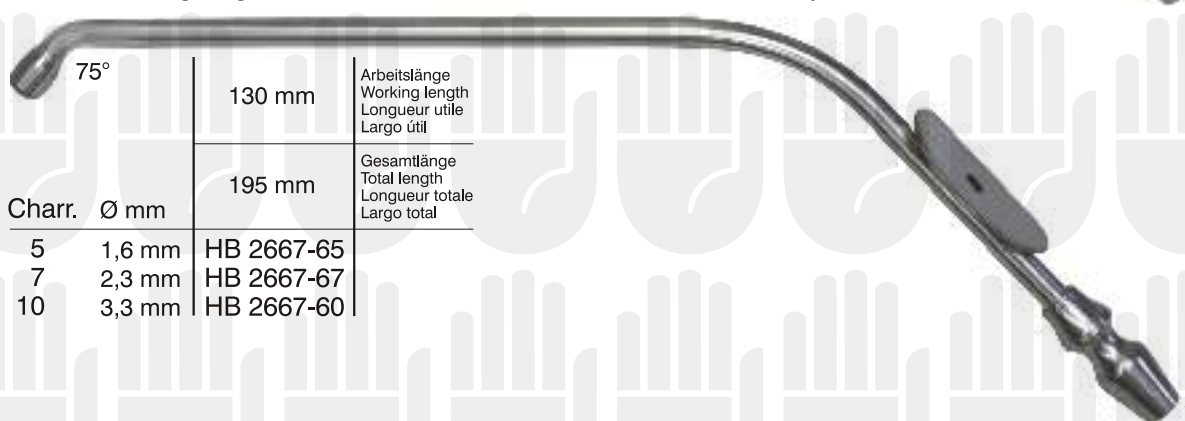

Charr. Ø mm		130 mm	Arbeitslänge Working length Longueur utile Largo útil
		195 mm	Gesamtlänge Total length Longueur totale Largo total
5	1,6 mm	HB 2667-65	
7	2,3 mm	HB 2667-67	
10	3,3 mm	HB 2667-60	