



ATLAS

DIVAN D'EXAMEN ÉLECTRIQUE
ELECTRIC EXAMINATION TABLE

Capacité / Capacity
385 KG

L'assurance du confort, de la sécurité et de la dignité de vos patients
Comfort, safety and patient dignity ensuring efficient patient care





Position basse
Low position



Position d'accueil
Welcome position



Procline
Reverse trendelenburg



Déclive
Trendelenburg



Sécurité totale – Total safety

Le divan ATLAS, avec une capacité de charge de 385 kg, permet de lever vos patients en toute sécurité, rapidement et pour longtemps (testé en statique à 2 000 kg par un organisme indépendant). Équipé de capteurs de sécurité, les mouvements du divan s'arrêtent instantanément en cas de faible pression sur la base de divan.

The ATLAS table, with its 385kg weight capacity, enables you to safely lift your patients time and time again (tested at a static weight of 2000kg by an independent organisation). Equipped with safety sensors, table movements are immediately stopped if pressure is applied to the base cover.



capacité
385 kg
capacity



14200-10

Multipositions – Multiposition

Les mouvements du dossier, d'élévation et de procline/déclive sont électriques pour faciliter votre examen.

Electrical backrest, height, seat tilt adjustments and Trendelenburg movements ensure that your examination is more efficient.

Accessibilité et dignité pour vos patients Accessibility and dignity for your patients

Le divan ATLAS a une hauteur minimum d'accueil de 48 cm, indispensable pour placer vos patients sur le divan et les relever avec une assistance minimum. Une largeur d'assise de 81 cm offre à votre patient le confort qu'il est en droit d'attendre.

The ATLAS table has a 48cm low height, ideal for patients to get onto and off the table safely and with minimal assistance. An 81cm wide seat provides the comfort and support your patient deserves.



Hygiène - Hygienic

L'entretien du divan ATLAS est rapide et facile; sellerie sans couture et carter ABS recouvrant. Les roulettes optionnelles facilitent le nettoyage sous la table.

Cleaning of the ATLAS table is quick and easy due to its seamless upholstery and formed ABS base. The optional castors allow for easy cleaning under the table.

CARACTÉRISTIQUES STANDARD STANDARD FEATURES

Capacité de charge : 385 kg
(testé en dynamique à 500 kg et en statique à 2000 kg)
Weight capacity : 385 kg (tested at a dynamic weight of 500kg and a static weight of 2000kg)

Dossier réglable par vérin électrique
(angle d'inclinaison de 0° à 65°)
Electric backrest adjustment (backrest angle from 0° to 65°)

Hauteur variable électrique de 48 cm à 88 cm
Electric height adjustment from 48cm to 88cm

Procline/Déclive de -15° à +15°
Trendelenburg/Reverse trendelenburg from -15° to +15°

Commande manuelle
Electric handset

Support rouleau papier (largeur maxi 60 cm Ø maxi 15 cm)
Paper roll holder (max. width 60cm max. Ø 15cm)

Structure acier avec habillage ABS gris nuage
Steel frame with light grey ABS casing

Sellerie plate sans couture avec revêtement classé M1
Seamless flat upholstery with flame retardant M1 covering



Commande manuelle
Handset



Support rouleau papier
Paper roll holder

ACCESSOIRES - ACCESSORIES

85114-01



Paire de barrières
Pair of barriers

14220-01



Commande par pédale
Pedal control

166



Paire d'étau
Pair of clamps

2985-01

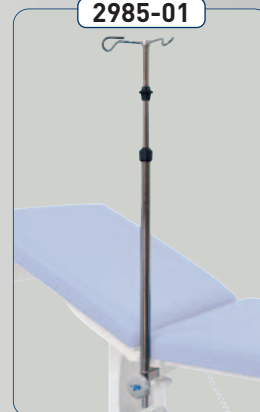

Tige porte sérum
IV pole

MAXI
88 cm

MINI
48 cm

14230-01



4 roulettes ø 75 mm avec freins
4 castors ø 75mm with brakes

OPTION

Capacité de charge sur roulettes : 295 kg (roulettes permettant le déplacement du divan, sans patient, pour nettoyage. Hauteur variable avec roulettes : 50 à 90 cm).

295kg weight capacity with castors (castors allow for the table to be moved, without patients, for cleaning. Height adjustment with castors from 50 to 90cm).

DIMENSIONS (mm)

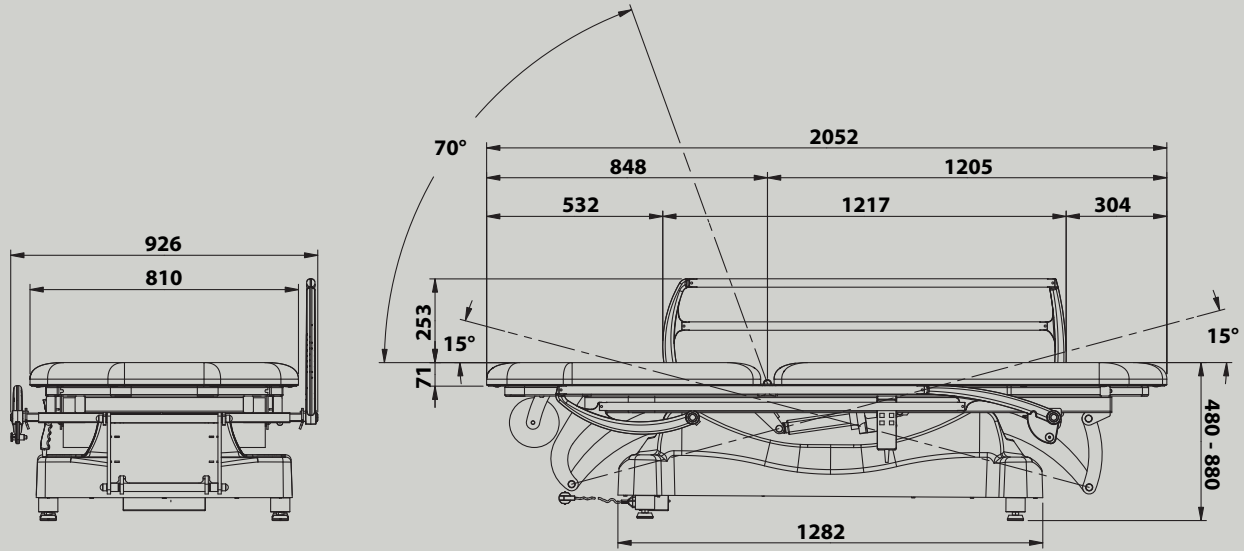

Poids net / Net weight 140 kg Poids brut / Gross weight 223 kg Volume 1,22 m³

CHOIX DES COULEURS DE SELLERIES - CHOICE OF UPHOLSTERY COLORS

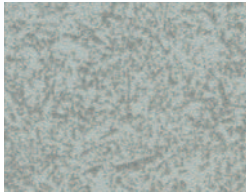

GALET

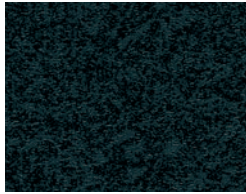

ANTHRACITE

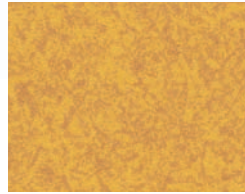

POLLEN

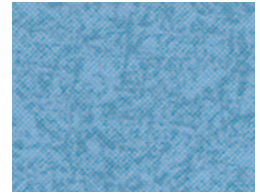

EGEE



AMANDE

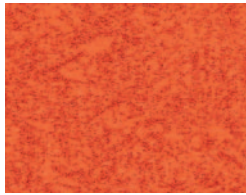

POTIRON

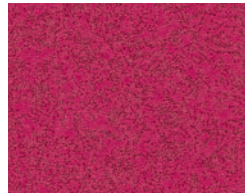

FUSCHIA

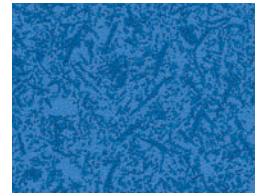

COBALT

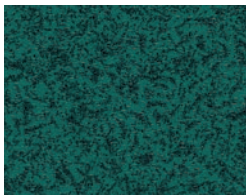

MALACHITE



ORAGE



TERRA COTTA

CRÉER VOTRE CABINET MÉDICAL CREATE YOUR PROMOTAL OFFICE

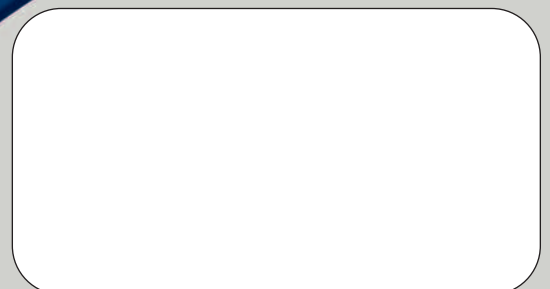

PROMOTAL - FRANCE
www.promotal.com

A002/FE-02/08

